

HARDWARE MANUAL

IHP24-BF



Table of contents

1	General.....	3
1.1	Safety instructions.....	3
1.2	Environment.....	3
1.3	Mounting and dimension.....	3
2	Communication.....	5
2.1	Control loopwith HART – AI0 and Transmitter loop – AO0	5
2.1.1	Terminals	5
2.1.2	Electrical specifications	5
2.2	Foundation Fieldbus.....	6
2.2.1	Terminals	6
2.2.2	Electrical specifications	6
3	Power supply – PS2	7
3.1	Terminals	7
3.2	Electrical specifications	7
4	4-20mA input – AI1	8
4.1	Terminals	8
4.2	Electrical specifications	8
5	Position sensor – AI10	9
5.1	Terminals	9
5.2	Electrical specifications	9
6	Digital output – DO1, DO2, DO3, DO4	10
6.1	Terminals	10
6.2	Electrical specifications	10
7	Digital input – DI9	11
7.1	Terminals	11
7.2	Electrical specifications	11

1 General

This manual covers the following products:

IHP24-BF-100000
IHP24-BF-300000

1.1 Safety instructions

For a safe installation of a Val Controls device, the following must be observed. The module must be installed by qualified personnel who are familiar with the national and international laws, directives and standards that apply to this product as well as all instructions in this manual.

The information in this manual is subject to changes without notice.

1.2 Environment

Operating temperature: -30 to 80 °C
Storage temperature: -30 to 80 °C

Relative Humidity: < 95% (No condensation)

The printed circuit boards are coated for tropical climate and harsh environments to resist airborne contamination according to G3, ISA-71.04-2013.

Material: SS316L (ASTM A351-00 CF3M)
Surface finish: Electro polished

Ingress protection: IP66/67/68

1.3 Mounting and dimension

Screw torque: 3.5 lb in
Wire diameter: AWG14-22 (0.5mm² til 2.5mm²)

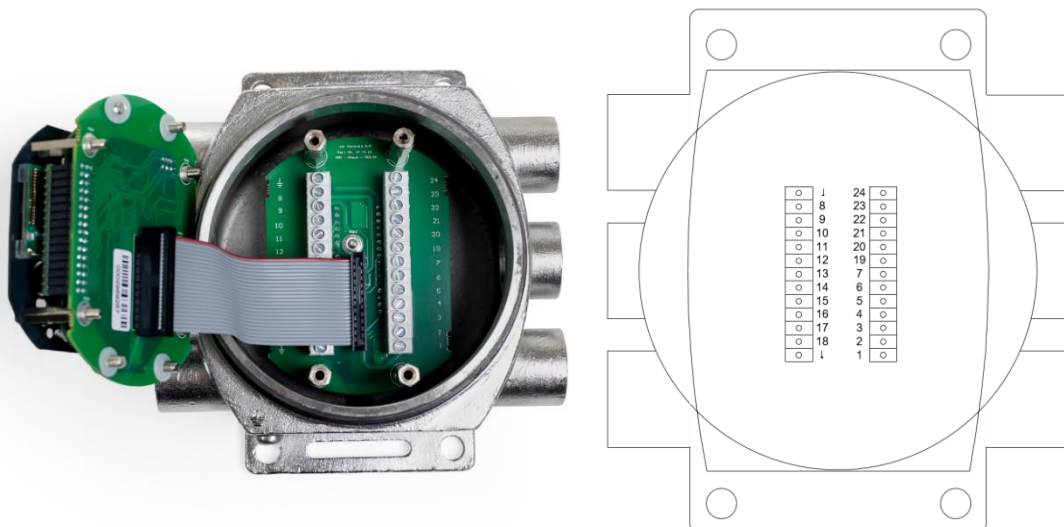

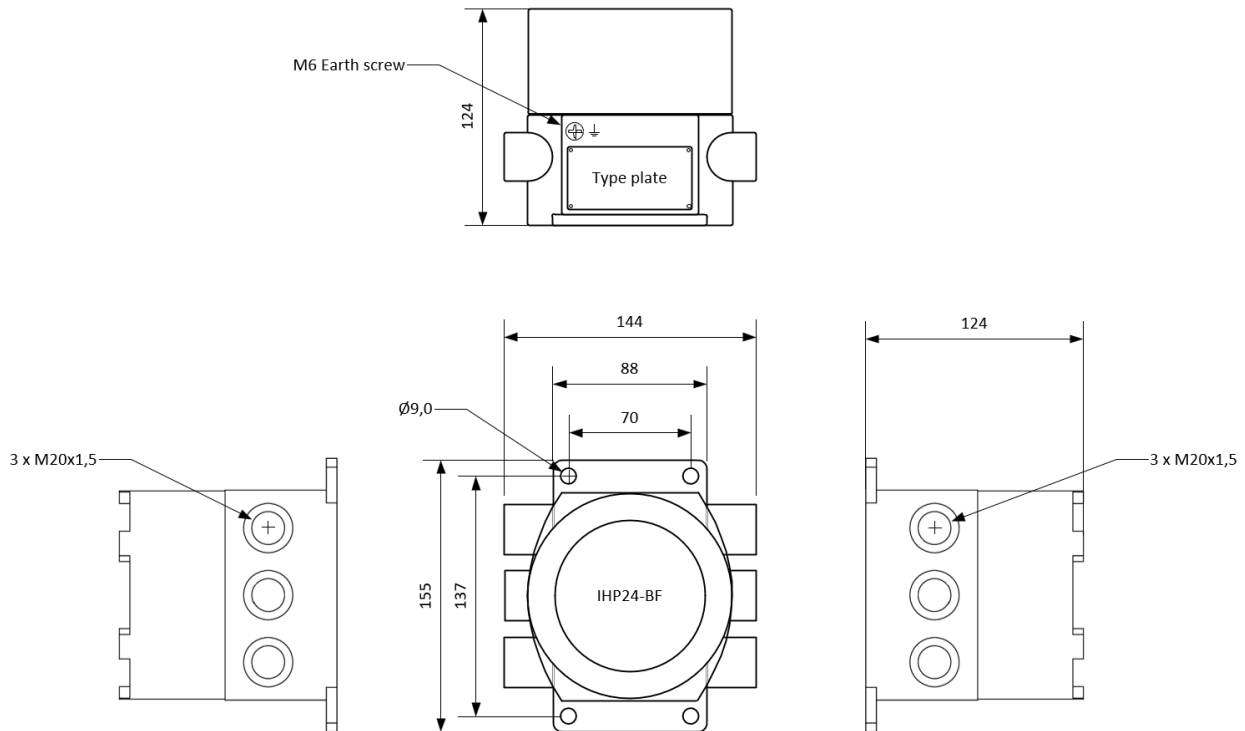

Ex marking:

All external components must have specifications that fit the desired performance and requirements of the valve/actuator system.

After installation the lid has to be closed properly to maintain the IP rating.

The O-ring is as standard treated with Molykote 55 O-ring grease. To maintain the IP rating the O-ring has to be treated every 2nd year with Molykote 55 O-ring grease or similar.

2 Communication

There are two type of communication available HART and FF.

For model: IHP24-BF-100000 go to 2.1 Control loopwith HART – AI0 and Transmitter loop – AO0.

For model: IHP24-BF-300000 go to 2.2 Foundation Fieldbus.

2.1 Control loopwith HART – AI0 and Transmitter loop – AO0

Passive 4-20mA input and passive 4-20mA output. HART is available on AI0.

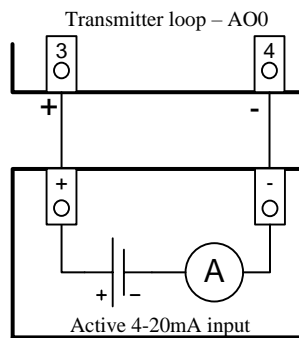
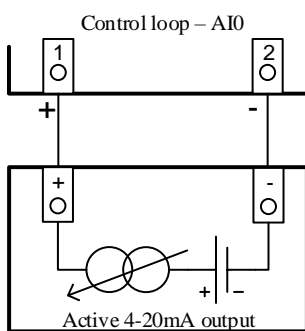

2.1.1 Terminals

AI0	1 (+) 2 (-)
AO0	3 (+) 4 (-)

2.1.2 Electrical specifications

Control loop – AI0	
Impedance	< 470 Ohm at 20mA and 9.4VDC
Linearity	< 0.1%
Temperature coefficient	0.025% / 1°C (Warm-up: 10 min)
HART (optional)	FSK, 1200Hz / 2200Hz 400-800mVpp
Galvanic isolated	
Transmitter loop – AO0	
Impedance	< 470 Ohm at 20mA and 9.4VDC
Linearity	< 0.1%
Temperature coefficient	0.015% / 1°C (Warm-up: 10 min)
Galvanic isolated	

2.2 Foundation Fieldbus

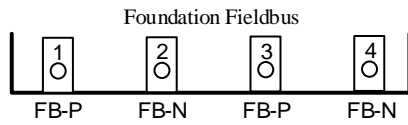

2.2.1 Terminals

Foundation Fieldbus	
Foundation Fieldbus	1 (FB-P)
	2 (FB-N)
	3 (FB-P)
	4 (FB-N)

2.2.2 Electrical specifications

FF-Fieldbus	
Interface	FF-Fieldbus - H1 Device Class – Basic Device
Termination	No internal termination

3 Power supply – PS2

24VDC power input to the device.

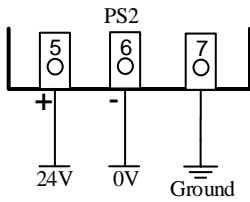

Depending on device configuration, this power supply input may not be used.

3.1 Terminals

PS2	5 (+) 6 (-) 7 Ground
-----	----------------------------

3.2 Electrical specifications

Power supply – PS2	
Power supply	20.4 – 27.6VDC
Power dissipation, no position sensor/loop or valves are connected.	< 2W
Power dissipation, with maximum load on all inputs and outputs	< 5W

4 4-20mA input – AI1

The analogue inputs can be used to connect passive 4-20mA sensors to the device or in the alternative configuration active 4-20mA sensors.

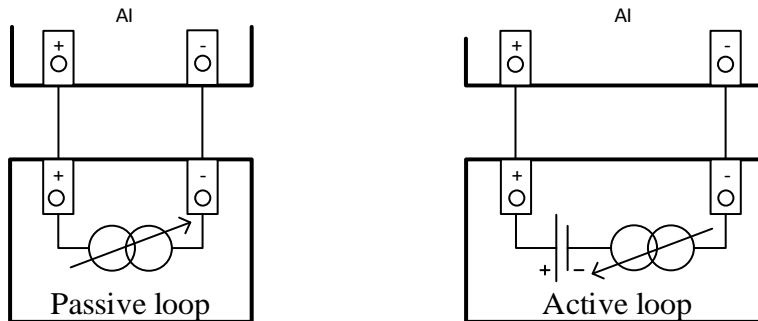

4.1 Terminals

	Passive sensor	Active sensor
AI1	11 (+) 12 (-)	12 (+) 6 (-)

4.2 Electrical specifications

AI – Analogue inputs	
External loop max Rload	820 Ohm at 20mA and 16.4VDC
Operating area	4 – 20mA
Minimum span	12mA
Cable length	1000 meters
Linearity	< 0.1%
Temperature coefficient	0.01% / 1°C (Warm-up: 10 min)
Rin	< 100 Ohm

5 Position sensor – AI10

The position feedback can be delivered from a 3-wire potentiometer.

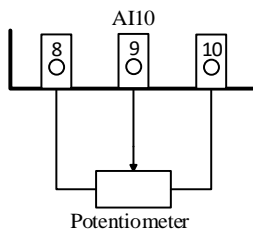

5.1 Terminals

	Sensor
AI10	8 Pot high 9 Wiper 10 Pot low

5.2 Electrical specifications

AI10 – Position sensor	
Potentiometer size	5 k Ω to 20 k Ω
Minimum use operating area	40%
Cable length	1.5 meters
Linearity	< 0.1%
Temperature coefficient	0.01% / 1°C (Warm-up: 10 min)

6 Digital output – DO1, DO2, DO3, DO4

24 VDC digital outputs.

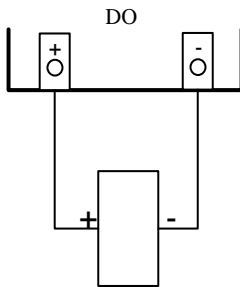

6.1 Terminals

DO1	13 (+) 14 (-)
DO2	16 (+) 17 (-)
DO3	19: (+) 20: (-)
DO4	22: (+) 23: (-)

All DOs (-) are common with PS2 (-)
All grounds are common with PS2 ground

6.2 Electrical specifications

DO – Digital outputs	
Max load per digital output	up to 48W at 24VDC
Max load total	up to 192W at 24VDC

7 Digital input – DI9

DI9 substitutes AI10

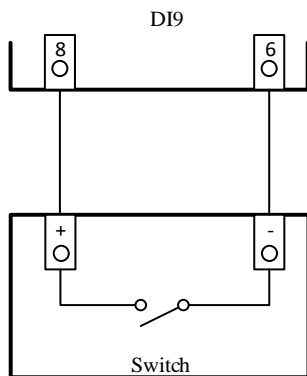

7.1 Terminals

DI9	8 (+) 6 (-)
-----	----------------

7.2 Electrical specifications

DI12	
Type	Switch
Cable length	1.5 meters